



Integration and configuration expertise matter – select the right laser solution for your application

Laser Marking Solutions

CO₂ and fibre laser product range





Videojet – delivering your desired mark.

To a greater degree than other coding processes, a successful laser mark is driven by a deep understanding of the interaction between coding technology and substrate. Successful marking requires a broad range of laser technologies and the accumulated knowledge of thousands of applications. With over 30 years of laser application expertise and a laser portfolio including CO₂, fibre and other solid-state lasers, Videojet is uniquely positioned to deliver your desired mark.

Laser marking – specifying excellence

Mark quality and permanence, high uptime and simplified maintenance are but some of the reasons to select laser marking technology for your operations. But not all lasers and not all laser suppliers are the same. Specifying a successful solution starts by working with the right partner – one who brings the broadest range of tools, application knowledge and field support. Since 1985, Videojet has been working continuously on laser innovation to bring the broadest substrate and application coverage possible to the packaging industry.

Uptime advantage

Long-life laser sources, minimal maintenance and low consumables help reduce both unscheduled and scheduled downtime and ensure few interventions during typical production periods. Installation set-up and line changeover procedures are quick, with innovative design features and intuitive software tools to further maximise printer availability.

Code Assurance

Our optional advanced CLARiTY™ laser controller helps prevent coding mistakes by reducing operator inputs into the coding and marking process. Onboard Code Assurance means you get the right code in the right place, on the right product, time after time.

Built-in productivity

High-speed variable coding and data buffering, combined with some of the largest mark windows in the industry, help increase throughput and performance. The CLARiTY™ laser controller gives instant data on fault information to help get the line back up and running. Advanced productivity tools help identify the root cause of downtime events to help you make process improvements.

Simple usability

Videojet offers a diverse range of standard configuration options and accessories to help ensure the laser works with your production workflow. Combined with easy operation, this means your team can focus more on production and less on user interaction and maintenance.

A laser solution for virtually any application

CO₂ laser systems

1. Paper & paperboard
2. Painted wood
3. Cardboard
4. Sticky label
5. Box board
6. Carton
7. Rubber
8. Glass
9. Wood
10. Lollipop sticks
11. Paper cup
12. Metallised carton

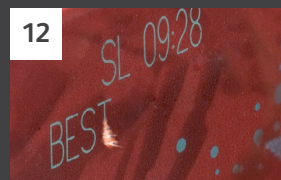
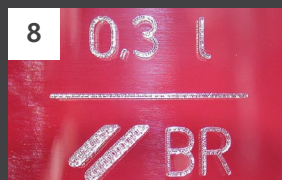
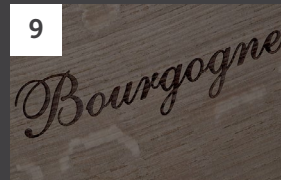
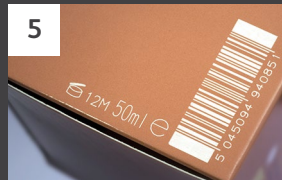

Fibre laser systems

1. Nickel tube
2. Metal
3. Automotive plastics
4. Labels
5. Glass
6. Plastic pipe
7. Medical closures
8. Plastic tub
9. Automotive stainless steel
10. Automotive switches
11. Metal cans
12. Plastic bottle closures



Achieving the ideal mark for your specific substrate and application relies on the optimum specification of laser source type and power, marking head and lens as well as various other factors that will impact the desired mark effect. We know laser marking, and have been committed to developing laser technology since 1985. This enables us to offer the most versatile range of laser systems to match the exact application need.

CO₂ laser and fibre laser systems

1. Metal caps
2. Circuit board
3. Electrical components
4. Pharmaceutical foil
5. PVC
6. Aseptic packaging
7. Plastic tube
8. Flexible material

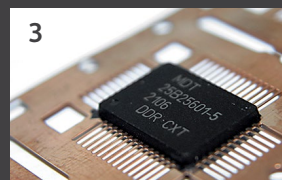
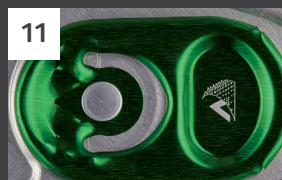
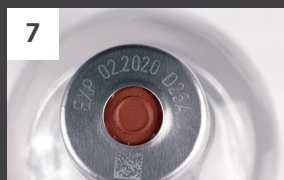
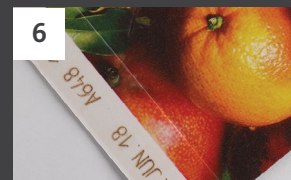
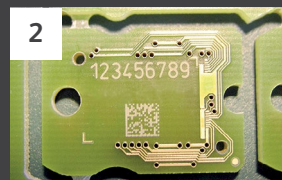
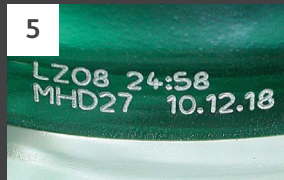

Our laser marking systems and solutions

CO₂ laser systems

Consistent high-quality on a wide range of materials

For crisp, high-quality codes - you can rely on the performance of the Videojet CO₂ laser range. Our products are designed to meet the needs of most consumer packaged goods applications by providing maximum uptime, increased productivity and the most flexible configuration options for line integration.

3350 3350 Smart Focus



With unparalleled digitally-enabled capabilities, the **3350** 30-watt CO₂ lasers are the ultimate solution for marking complex and high-quality codes at lightning-fast speeds in various industries such as food, beverage, cosmetics, pharmaceutical and extrusion. The advanced **3350 Smart Focus** model is equipped with cutting-edge automatic and dynamic marking capabilities, allowing for seamless product changeovers without any manual intervention.

- Automatically adjust the focal distance after initial job setup without moving the laser
- Virtually no font, code or graphic restrictions
- Print speeds up to 2,000 characters/sec.
- Easy and secure wireless communication with the marking system simplifies integration
- Variety of lenses deliver one of the largest marking areas while options like beam turning unit simplify integration

3140



The **3140** is a 10-Watt CO₂ laser engineered for packaging professionals that require high-quality marking at moderate line speeds. Designed for maximum uptime and reliability, the 3140 provides a laser source life expectancy of up to 45,000 hours.

- Large selection of mark window options helps to code faster and more efficiently
- 32 standard beam delivery options for integrating the laser into your packaging or filling equipment provides the best system uptime
- Unique features, such as a detachable umbilical cable, designed to simplify integration with your line
- Print speeds up to 2,000 characters/sec
- Line speeds of up to 900m/min

3640



The **3640** is a 60-Watt CO₂ laser marking system engineered to help address high volume and highest speed applications in the pharmaceutical, tobacco and beverage markets. It has been designed to process complex codes at high speeds, with the industry's widest mark field.

- Fastest laser marking system in the industry with print speeds up to 2,100 characters/sec. and up to 150,000 products/hour
- Fast serialisation for pharmaceutical and tobacco applications, delivering unique and serialised codes at high production speeds
- Large marking field reduces the number of lasers required to cover multi-lane/wide web applications, reducing costs
- Efficient and low maintenance air-cooled laser source plus virtually no consumables provide an easy-to-maintain, highly reliable system that requires minimal intervention

Wavelengths:

Our CO₂ range of lasers are available with various wavelengths to help match the ideal solution to the exact application.

Fibre laser systems

Small but powerful marking solutions for robust substrates

The fibre laser range was developed to meet the needs of manufacturers who work with robust, high-density packaging materials on moderate- or high-speed lines. Industries including beverage, extrusion and pharmaceutical that run demanding production schedules with increasing throughput expectations need a laser that can keep pace and provide a level of contrast that meets or exceeds expectations.

7340/7440



The **7340** and **7440** are 20-Watt and 30-Watt versatile fibre laser marking systems. They are the first to feature Lightfoot™, the smallest fibre laser marking head on the market, making them easy to integrate, operate and service.

The 7340 and 7440 are designed to deliver high-quality, permanent codes for a wide range of marking applications in the parts-marking, food, beverage, consumer packaged goods, pharmaceutical and cosmetics industries.

- Mark up to 2,000 characters/sec.
- Simple integration, reduced installation costs and increased freedom of positioning with an industry-first, compact laser marking head
- Easy set-up and fast product changeovers with the integrated pilot beam focus finder that can reflect the code and actual size of the marking field
- IP69 laser marking head for worry-free usage in washdown and harsh environments

7230/7330



The **7230** and **7330** are 10-Watt and 20-Watt pulsed fibre lasers, respectively. They are some of the most compact, flexible and low maintenance marking systems available.

The 7230 and 7330 have been designed for direct parts marking and unique identification applications on metals, plastics and other hard-to-mark materials in the aerospace, automotive, consumer packaged goods, beverage, electronics, medical devices and tools markets.

- Ultra-reliable fibre laser source lasts up to 100,000 hours and eliminates pump chamber maintenance common with Nd:YAG lasers
- Ultra-precise beam control provides high-quality, high-density codes at fast speeds on multiple high-density substrates without damaging product aesthetics
- Ytterbium laser source is tuned for high-quality marking of metal and plastic materials
- Ultra-compact design with flexible configuration options for seamless integration

7510/7610



The Videojet **7510** 50-Watt and Videojet **7610** 100-Watt fibre laser marking systems deliver advanced performance for high-contrast marking on robust plastic packaging, metal containers and other industrial products, even at ultra-fast line speeds up to 600m/min.

The 7510 and 7610 have been specifically engineered for high-speed tobacco, pharmaceutical and extrusion manufacturers, delivering better mark quality, higher efficiency and a dramatically smaller marking unit than traditional solid-state laser systems.

- Highly efficient air-cooled laser source virtually eliminates maintenance intervals
- High-precision scan head delivers consistent high-quality codes across the entire mark window
- Two beam turning units plus working distance options provide installation flexibility

CLARiTY™ laser controller for simple operation and reduced coding errors

CLARiTY™ laser controller addresses production line realities where downtime is not an option and maximum productivity means getting the right code on the right product, time after time.

Our CLARiTY™ intuitive touchscreen interface features built-in Code Assurance software to minimise and mistake-proof inputs to the coding and marking process, while significantly reducing operator errors.

In addition, on-screen diagnostics track the causes of downtime and help with troubleshooting to get your line back up and running quickly. Simple operation, designed with tools to drive continuous, sustainable improvements, helps enhance your uptime and productivity.

Code Assurance

Bad codes can mean waste, rework, regulatory fines and potential damage to your brand. We will help you keep your line productive and your brand protected.

Packaging facilities often experience coding errors - codes that are one digit off, dates that don't exist, codes on wrong products, typing errors, wrong offset dates. Research shows that in 50% – 70% of cases, these are likely to be operator errors.

Available with any CO₂ and most fibre Videojet laser marking systems, the Videojet CLARiTY™ laser controller takes a comprehensive approach to printing the right codes on the right products by minimising and mistake-proofing operator inputs to the coding and marking process.

Users create simple error-proofing rules during setup – for example, whether or not fields can be edited, permissible data types and date range restrictions. The operator is limited to specified choices, with field prompts, drop-down menus, calendar displays and predefined formats that help ensure correct entries time after time.



Survey: Frequency of coding errors

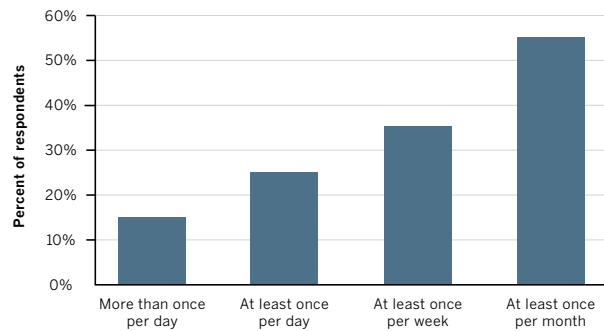

Survey: Cause of coding errors

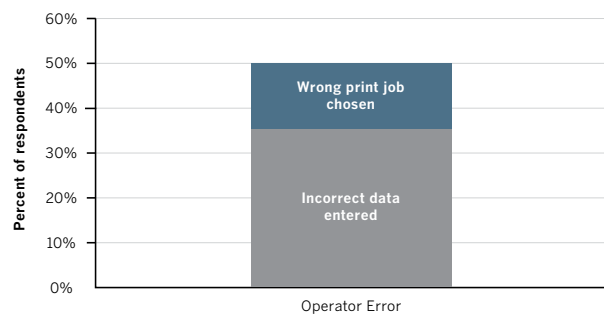



Visual job selection

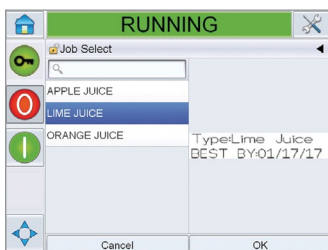

Job files can be saved and searched using meaningful names, such as the product that is being coded. Message preview provides additional confidence that the right job is loaded.

Minimal choice for minimal errors

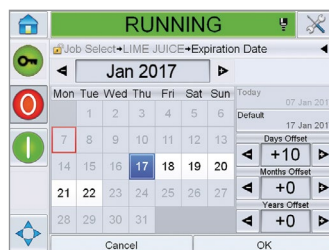

Limited data-entry choices

Entering a date? Calendar shows allowable expiry dates only.

A country code? Choose from a drop-down list.

Complex codes? Load into a pre-defined format automatically.

Step-by-step guided entry

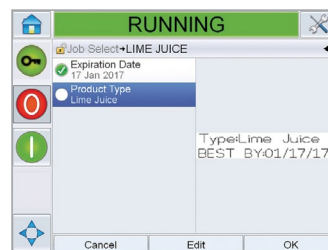

Based on pre-defined job set-up rules, only permissible fields can be edited. The print job can be loaded only after the operator has confirmed each entry.

Print preview

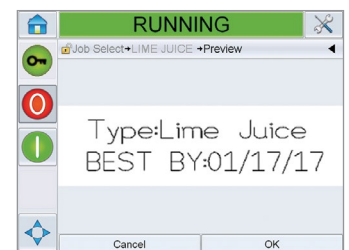

A preview of print layout confirms the correct job has been loaded and gives operators confidence that the data entered is correct prior to printing.

Minimise and mistake-proof inputs to the coding and marking process, while significantly reducing operator errors.

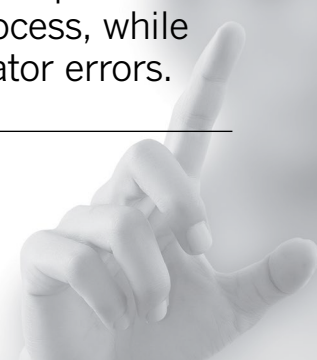

Integration flexibility comes as standard

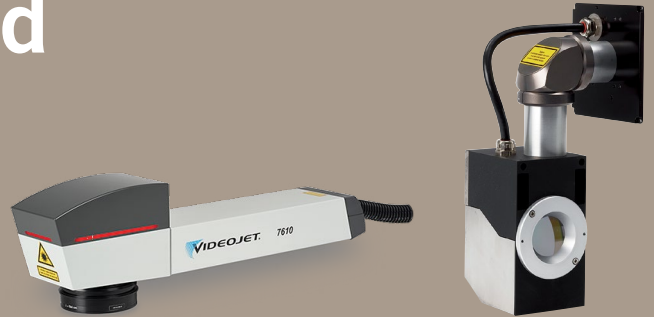

CO₂ laser systems

Over 20,000 standard configurations deliver flexibility to fit your line with minimal disruption:

- 32 Marking head positions
- 21 Mark windows
- 3 Wavelengths
- 2 IP ratings for marking units (IP54, IP65)
- 3 Detachable umbilical lengths
- 3 Power options (10-Watt, 30-Watt and 60-Watt)

Fibre laser systems

Engineered for seamless integration and to position the beam exactly where you need it.

These fibre laser marking units are dramatically smaller than the predecessor Videojet solid-state laser solutions, enabling far easier integration into packaging lines and equipment.

A choice of working distances, varying from 122mm to 543mm, enables users to work within the physical constraints of the packaging line. This, along with the choice of a straight or 90-degree marking head orientation, provides flexibility on production lines with space limitations.

Positioning the beam where needed

= 32 standard beam delivery options for marking head positioning

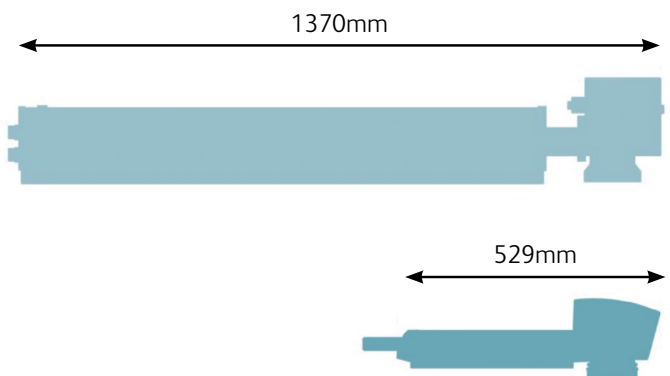
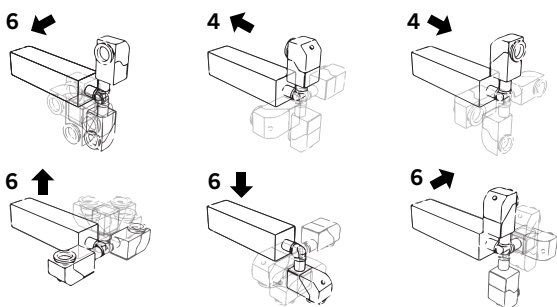

Size comparison is based on a Videojet 7610 fibre laser and 100-Watt Nd:YAG



High speed

Manufacturers can now benefit from marking products up to 60% faster than our previous laser.*

With an improvement in mark speeds, the Videojet 3640 laser marking system can mark five lines of variable data, plus 2D codes at 600+ products per minute.



The 60W 3640 CO₂ laser exceeds the requirements of most production lines today.

**Comparison between 3430 and 3640 Videojet lasers. Speed improvement is substrate dependent.*

Wide web

Designed to help with higher throughput and more efficient coding, the 3350 and 3640 range of Videojet CO₂ lasers has the widest marking window in the industry.

The marking field has been increased by 24% in comparison to our previous CO₂ laser range. The 3350 and 3640 laser marking systems can cover up to 600mm, meaning a variety of wide web applications can be addressed with one laser that previously would have required two lasers. The large selection of mark windows allows manufacturers to code more efficiently, providing more time to mark and increasing throughput and productivity.

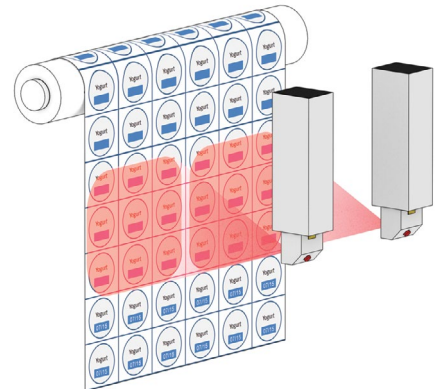

One 3350 or 3640 may cover a wide web application that previously would have required 2 lasers.

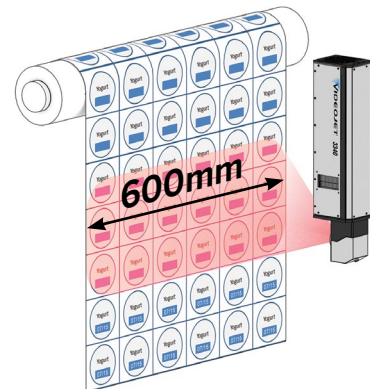

20% wider marking field than leading laser solutions on the market today.

Peace of mind comes as standard

Videojet Technologies is a world-leader in the product identification market, providing in-line printing, coding and marking products, application-specific fluids and product life cycle services.

Our goal is to partner with our customers in the consumer packaged goods, pharmaceutical and industrial goods industries to improve their productivity, to protect and grow their brands and to stay ahead of industry trends and regulations. With our customer application experts and technology leadership in Continuous Inkjet (CIJ), Thermal Inkjet (TIJ), Laser Marking, Thermal Transfer Overprinting (TTO), case coding and labelling and wide array printing, Videojet has more than 400,000 printers installed worldwide.

Our customers rely on Videojet products to print on over ten billion products daily. Customer sales, application, service and training support is provided by direct operations with over 4,000 team members in 26 countries worldwide. In addition, Videojet's distribution network includes more than 400 distributors and OEMs, serving 135 countries.

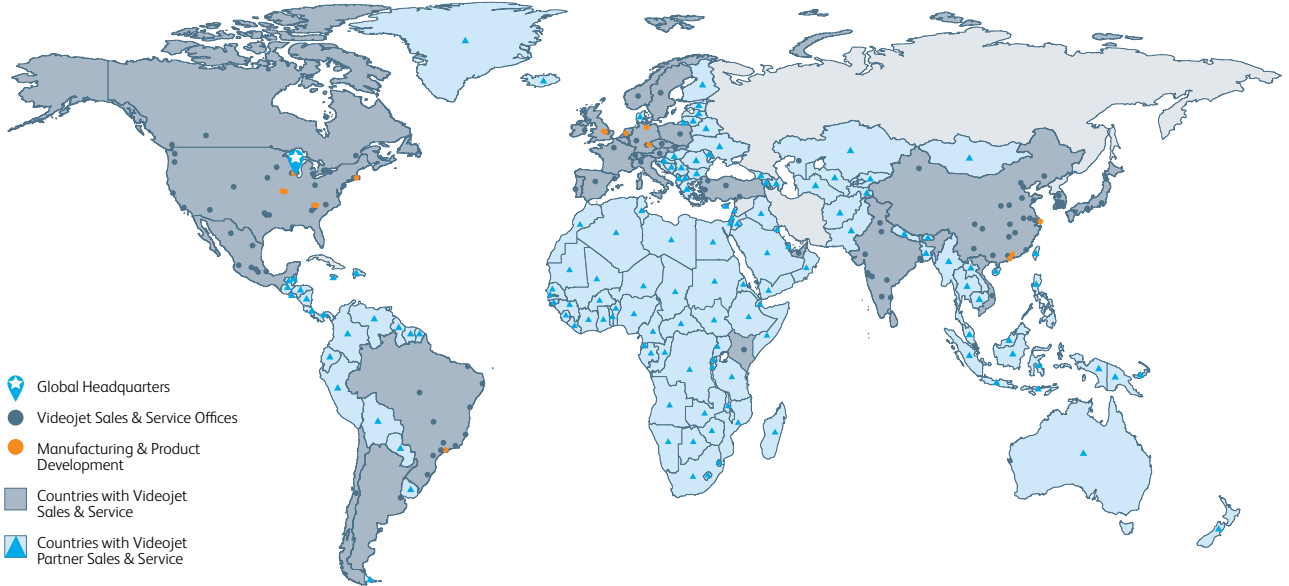

Call **(65) 6349 2282**
Email **marketing.singapore@videojet.com**
or visit **www.videojet.sg**

Videojet Technologies (S) Pte Ltd
1 Kaki Bukit View
#04-15/17 Techview
Singapore 415941

© 2024 Videojet Technologies Inc. — All rights reserved.
Videojet Technologies Inc.'s policy is one of continued product improvement.
We reserve the right to alter design and/or specifications without notice.

Part No. SL000604
br-laser-product-range-en-sg-0324

